

Varenummer: 4320000451
Beskrivelse: Rota-fix spændelement A 45x75
Rustfast stål

Mål

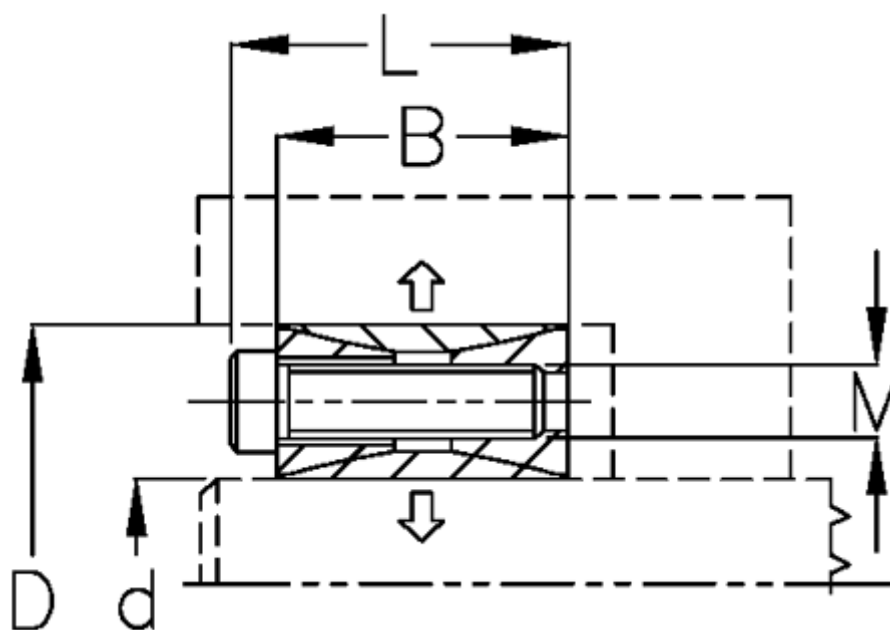

B mm	= 24
d H8 mm	= 45
D mm	= 75
F kN aksialkraft	= 44.7
L mm	= 32
M mm	= M8
Overfladeruhed	= R? ? 3.2 μ m
P N/mm ² fladetryk på aksel/nav	= 47

T Nm drejningsmoment	= 1000
Tolerance	= Aksel k11-h11, Nav M8
Ts Nm boltetilspændingsmoment	= 21.4